

COMMUNICATIONS

# Engineering Bulletin

By: Tom Bishop  
RF Circuits Engineering

## 140W (PEP) Amateur Radio Linear Amplifier 2-30MHz

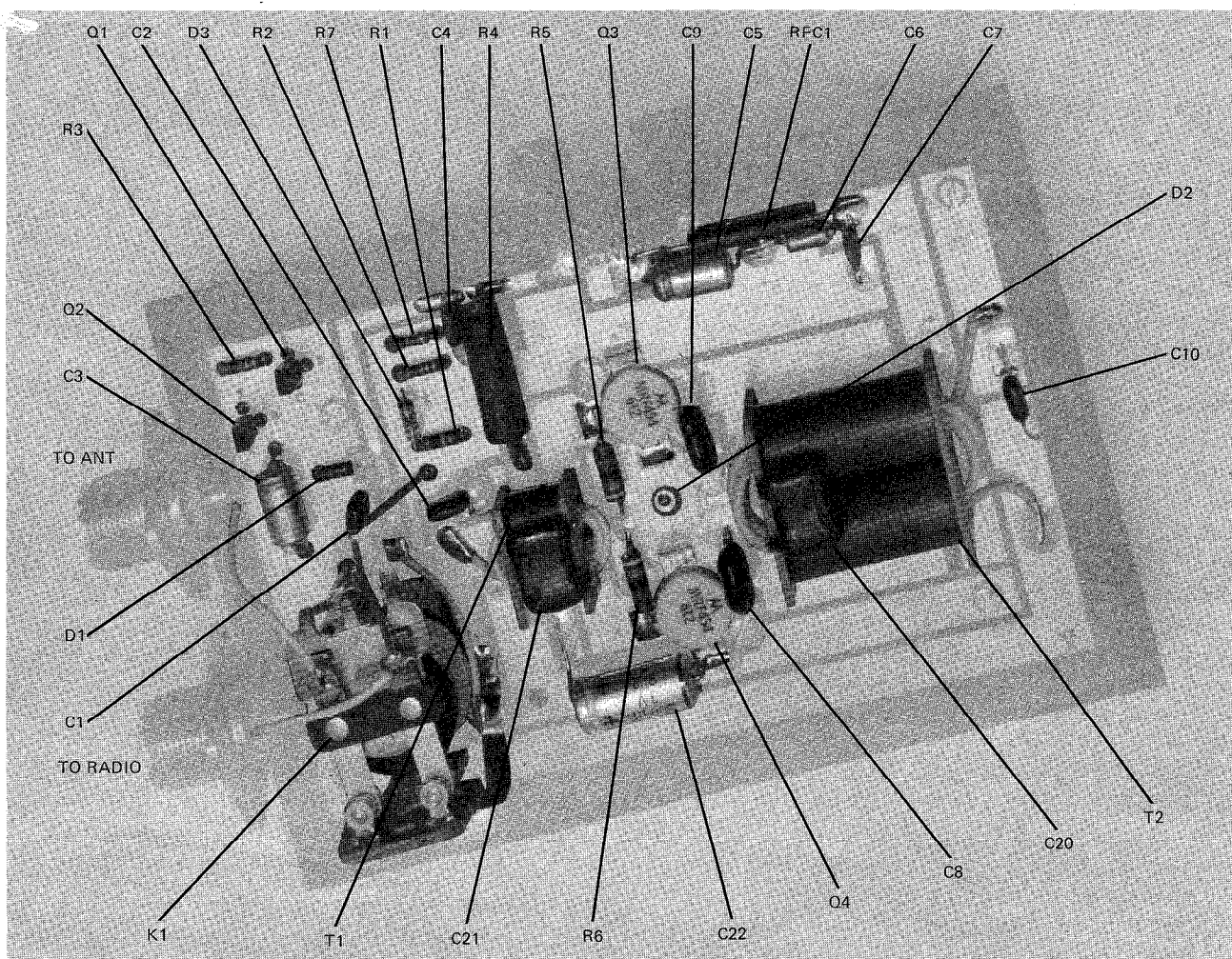

The popularity of 2-30 MHz, SSB, Solid State, linear amplifiers is increasing in the amateur market. This EB describes an inexpensive, easy to construct amplifier and some pertinent performance information. The amplifier uses two MRF454 devices. These transistors are specified at 80 Watts power output with 5 Watts of input drive,

30 MHz, and 12.5 Vdc. The MRF454 is used because it is a readily available device and has the high saturation power and ruggedness desired for this application. This device is not characterized for SSB. However, IMD specs for the amplifier are shown in Figures 2 and 3.

## THE AMPLIFIER

The performance of the amplifier can be seen in figures 1, 2, 3, 5, 6, 7 and 8. The quiescent current is 500 mA on each device. This amount of bias was needed to prevent "cross over" at the higher output powers during SSB operation. The amplifier operates across the 2-30 MHz band with relatively flat gain response and reaches gain saturation at approximately 210 Watts of output power. Figure 5 depicts the amplitude modulated waveform with respect to a 100-Watt carrier. Figure 6 depicts the increased amplitude modulation at 50-Watt carrier. In both cases the peak output power is equal to approximately 210 Watts due to the saturation of the MRF454. The 50-Watt carrier is thus recommended in any amplitude modulated applications.

The bias diode D2 has been mounted in the heatsink for temperature tracking. The cathode is pressed into the heatsink and the anode extends through the circuit board. (See figure 9.) Both input and output transformers are 4:1 turns ratio (16:1 impedance ratio) to achieve low input SWR across the specified band and a high saturation capability. T1\* is made from FairRite Products, ferrite beads, material #77, .375" O.D. x .187/.200" I.D. x .44L". T2\* is made from Stackpole Co. ferrite sleeves #57-0503-7D.

When using this design, it is important to interconnect the ground plane on the bottom of the board to the top; especially at the emitters of the MRF454s. Eyelets were used in this design, which are easier to apply, but #18 AWG wire can be used. On the photomask, (see figure 10) ":" signifies where the ground plane has been interconnected. The letter "O" designates where the 4-40 screws are installed to fasten the board to the heatsink. 6-32 nuts are used as spacers on the 4-40 screws between the board and the heatsink to keep the board from touching the heatsink.

## THE DESIGN

This amplifier was designed for simplicity. The design goal was to allow repeatability of assembly and reduce the number of components used. The amplifier will accept Single Side Band or Amplitude Modulation without external switching. A carrier operated relay circuit is on the same layout to make this an easy amplifier to add on to any suitable radio with an RF output of 1.0-5.0 Watts. All components used are readily available at most distributors and are relatively inexpensive.

NOTE: Similarly assembled transformers can be purchased from:

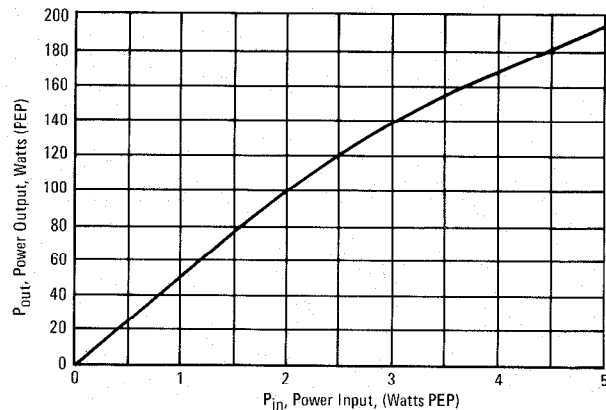

FIGURE 1—P<sub>out</sub> vs. P<sub>in</sub>, 30 MHz, 13.6 Vdc

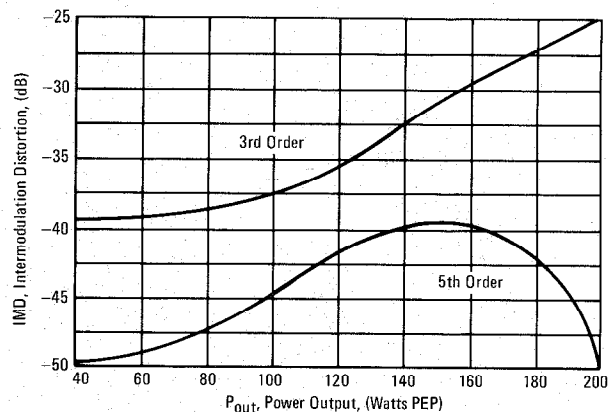

FIGURE 2—Intermodulation Distortion Versus P<sub>out</sub>, 30 MHz, 13.6 Vdc

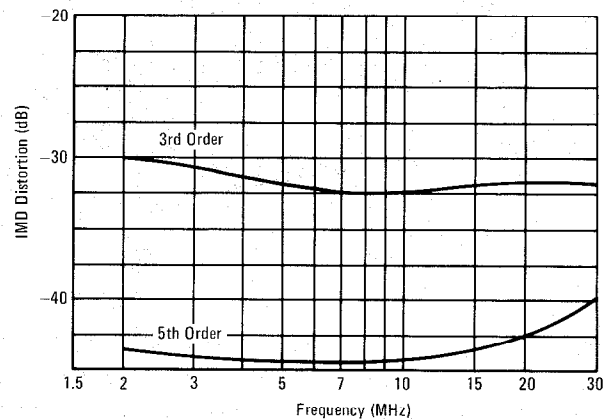
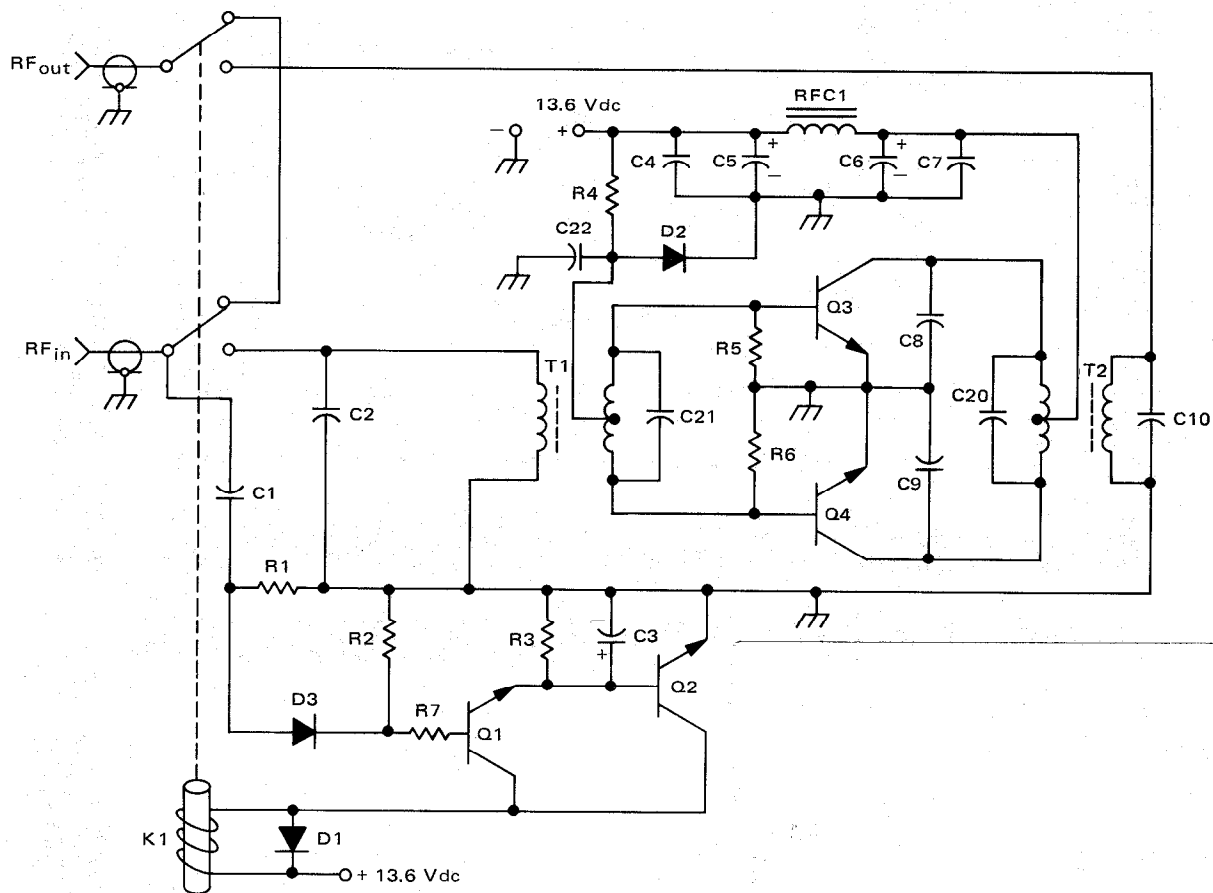

FIGURE 3—IMD vs. Frequency, P<sub>out</sub> = 140 Watt PEP, 13.6 Vdc

\* Ref: Application Notes

AN749 BroadBand Transformers and Power Combining Techniques for RF — H. Granberg

AN762 Linear Amplifiers for Mobile Operation — H. Granberg



- |       |  |        |  |
|-------|--|--------|--|
| C1    | = 33 pF Dipped Mica  | R7     | = 100 $\Omega$ 1/4 W Resistor                            |
| C2    | = 18 pF Dipped Mica  | RFC1   | = 9 Ferroxcube Beads on #18 AWG Wire                     |
| C3    | = 10 $\mu$ F 35 Vdc for AM operation,<br>100 $\mu$ F 35 Vdc for SSB operation. | D1     | = 1N4001   |
| C4    | = .1 $\mu$ F Erie  | D2     | = 1N4997   |
| C5    | = 10 $\mu$ F 35 Vdc Electrolytic   | D3     | = 1N914  |
| C6    | = 1 $\mu$ F Tantalum   | Q1, Q2 | = 2N4401   |
| C7    | = .001 $\mu$ F Erie Disc   | Q3, 4  | = MRF454   |
| C8, 9 | = 330 pF Dipped Mica   | T1, T2 | = 16:1 Transformers                                      |
| R1    | = 100 k $\Omega$ 1/4 W Resistor  | C20    | = 910 pF Dipped Mica                                     |
| R2, 3 | = 10 k $\Omega$ 1/4 W Resistor   | C21    | = 1100 pF Dipped Mica                                    |
| R4    | = 33 $\Omega$ 5 W Wire Wound Resistor  | C10    | = 24 pF Dipped Mica                                      |
| R5, 6 | = 10 $\Omega$ 1/2 W Resistor   | C22    | = 500 $\mu$ F 3 Vdc Electrolytic                         |
|       |  | K1     | = Potter & Brumfield<br>KT11A 12 Vdc Relay or Equivalent |

FIGURE 4—Schematic Diagram

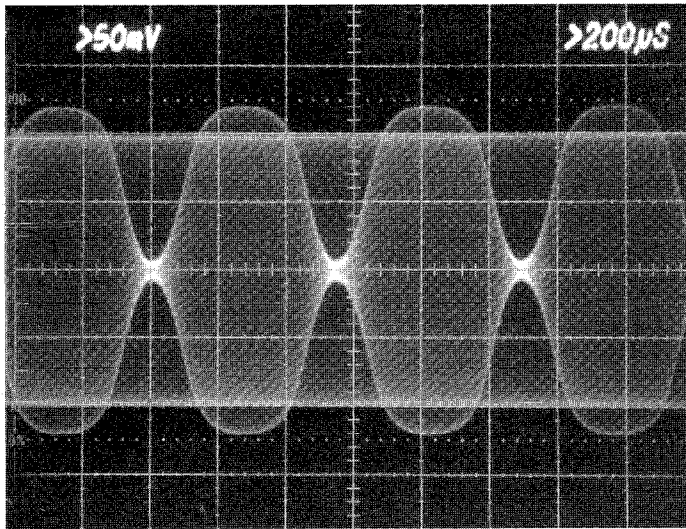

Amplitude Modulated Waveform with Superimposed Carrier. Carrier Conditions:  $f = 30 \text{ MHz}$ ;  $P_{in} = 2.2 \text{ Watts}$ ;  $P_{out} = 100 \text{ Watts (carrier)}$ ;  $V_{CC} = 13.6 \text{ Vdc}$

FIGURE 5

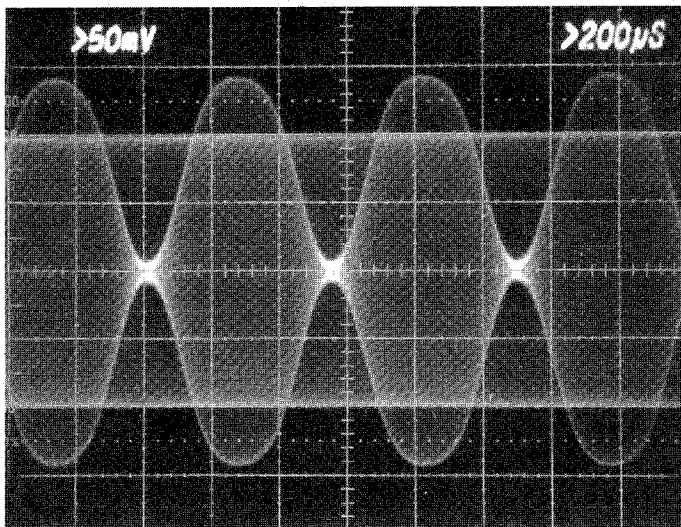

Amplitude Modulated Waveform with Superimposed Carrier. Carrier Conditions:  $f = 30 \text{ MHz}$ ;  $P_{in} = 1.3 \text{ Watt}$ ;  $P_{out} = 50 \text{ Watts}$ ;  $V_{CC} = 13.6 \text{ Vdc}$

FIGURE 6

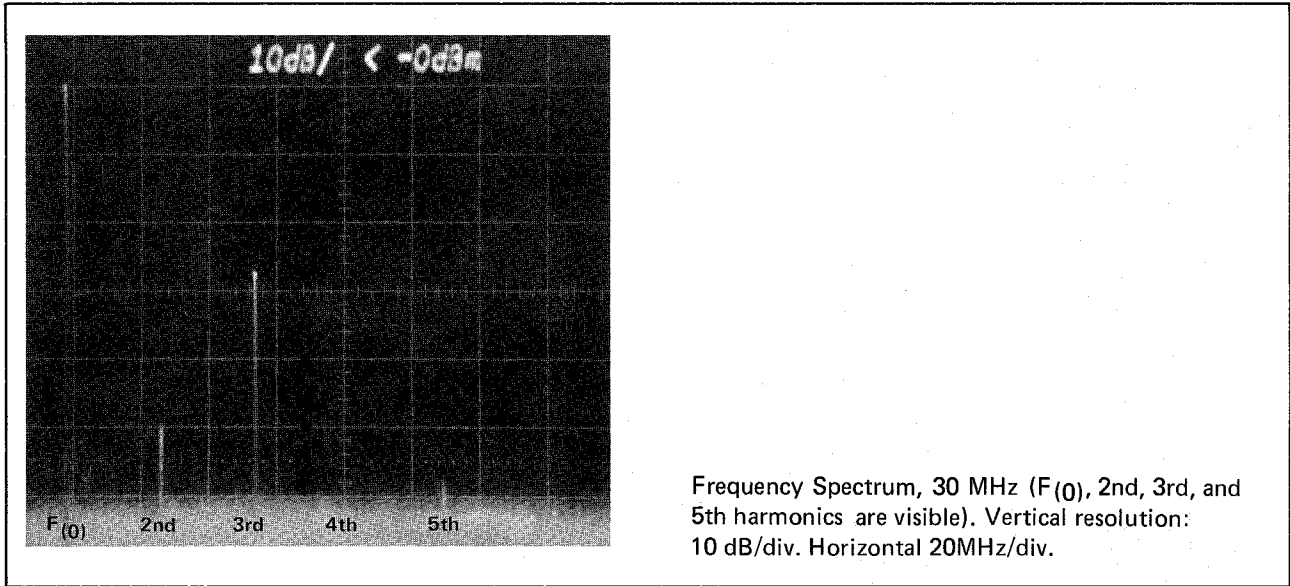

FIGURE 7

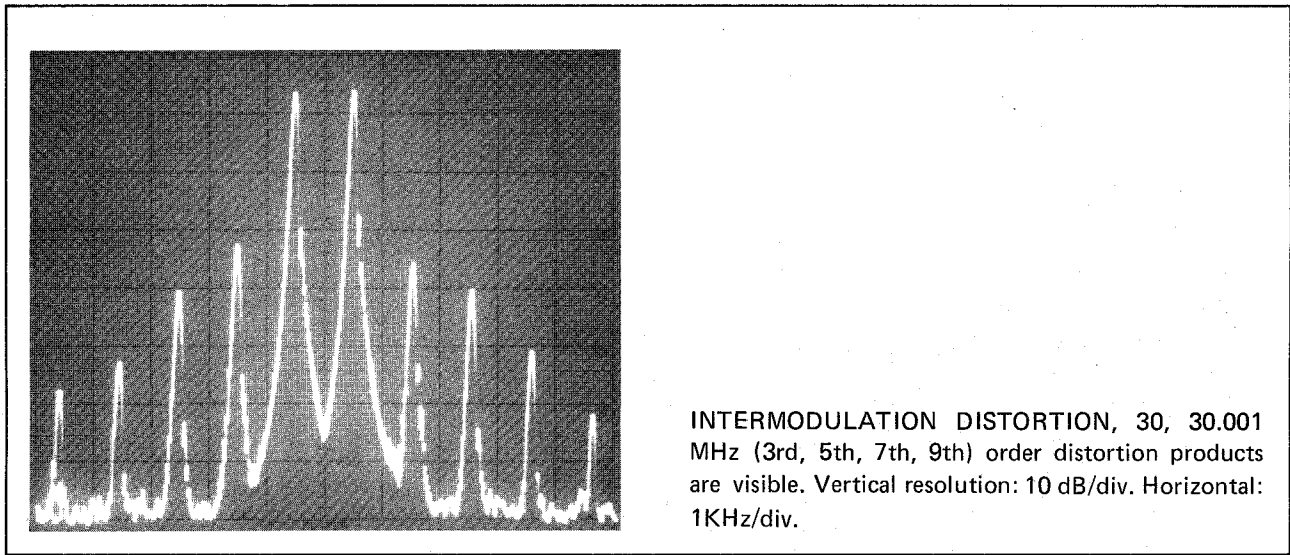

FIGURE 8

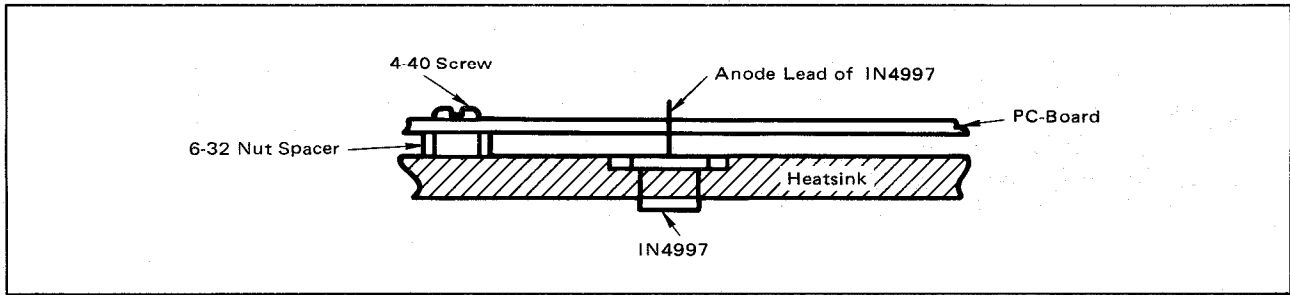

FIGURE 9 – Mounting Detail of IN4997 and 6-32 Nut (Spacer)

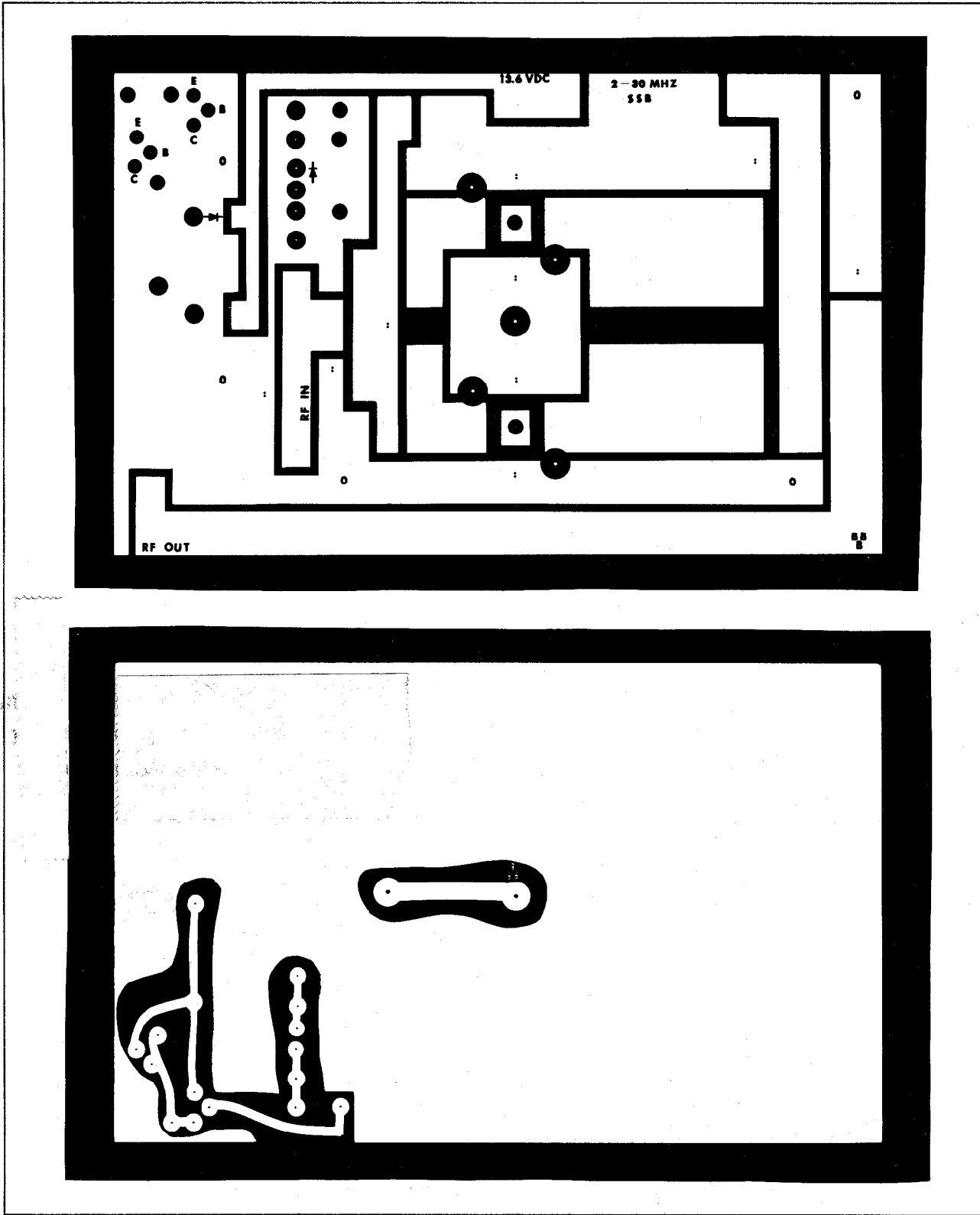

FIGURE 10-1:1 Photomaster (Positive)

Note: The use of this amplifier is illegal for Class D Citizen Band service.

Circuit diagrams external to Motorola products are included as a means of illustrating typical semiconductor applications; consequently, complete information sufficient for construction purposes is not necessarily given. The information in this Engineering Bulletin has been carefully checked and is believed to be entirely reliable. However, no responsibility is assumed for inaccuracies. Furthermore, such information does not convey to the purchaser of the semiconductor devices described any license under the patent rights of Motorola Inc. or others.



**MOTOROLA Semiconductor Products Inc.**

P.O. BOX 20912 • PHOENIX, ARIZONA 85036 • A SUBSIDIARY OF MOTOROLA INC.